

INSTRUCTION MANUAL

McINTOSH MODEL C-8 and C-8P

AUDIO COMPENSATORS

McINTOSH LABORATORY, INC.

320 Water St. Binghamton, N. Y.

U.S.A.

INSTRUCTION MANUAL

McINTOSH MODEL C-8 and C-8P

AUDIO COMPENSATORS

The McIntosh Audio Compensator is a complete control unit for professional or home entertainment systems. The Model C-8 derives its power from any McIntosh power amplifier: the Model C-8P is self-powered.

Five input channels are provided: three which produce constant amplification over the audio spectrum of 20-20,000 cycles, and two which are equalized for magnetic phonograph cartridges.

THE AUDIO COMPENSATOR IS A COMPLETE PRE-AMPLIFIER AND RECORD COMPENSATOR: THEREFORE, THE USE OF AN AUXILIARY EQUALIZER OR PRE-AMPLIFIER WITH THIS UNIT IS NOT RECOMMENDED.

INSTALLATION OF MODEL C-8 and C-8P, AUDIO COMPENSATORS

The C-8 and C-8P Audio Compensator may be mounted in any type equipment cabinet, relay rack panel, door, wall, etc., or in its own cabinet for chair side operation. It is not necessary to disassemble the Audio Compensator for mounting. Cut a rectangular hole in the panel to be used for mounting, insert the Audio Compensator, and secure with wood or machine screws. Mounting templates are provided with this manual for the C-8 and C-8P.

When installing the C-8P, the power supply section should be mounted at least two feet from the Audio Compensator.

After these units have been secured in their desired location, proceed as follows:

1. Connect speaker to output of power amplifier.
2. Insert power amplifier line cord into one of the Auxiliary A.C. receptacles provided at the rear chassis of the Audio Compensator.

3. C-8: Connect inter-unit cable to socket labeled "PRE-AMP. INPUT" on McIntosh power amplifiers.

CAUTION: THE INTER-UNIT CABLE MUST NOT BE REMOVED FROM THE C-8.

C-8P: Insert cable of D-8 power supply into socket labeled "INTER-UNIT CABLE" on C-8P. Connect audio cable provided between RETMA pin jack labeled "MAIN OUTPUT" on C-8P and 2.5V input of power amplifier. (Socket labeled "PRE-AMP INPUT" on McIntosh power amplifiers.)

4. The Audio Compensator delivers 2.5 volts of audio signal at full output. The gain control of the power amplifier should be adjusted as outlined in the amplifier instruction manual for this sensitivity.
5. Turn the volume control on the Audio Compensator to "OFF".
6. Insert power cord of the Audio Compensator into a 117 V.A.C. power outlet.
7. Turn the Selector switch on the Audio Compensator to "5" and Bass control fully clockwise.
8. Turn the volume control on the Audio Compensator clockwise until the power switch is activated. Allow thirty seconds for warm-up, then advance the volume control to "10".
9. C-8: Adjust the hum reducing potentiometer on the power amplifier for minimum hum.

C-8P: Adjust the hum reducing potentiometer on the power supply for minimum hum.
10. Turn the volume control on the Audio Compensator to off.
11. Insert inputs into their proper jacks at the back of the Audio Compensator, and all A.C. power cords into the A.C. outlets provided.

INPUT CONNECTING PROCEDURE

The inherent hum and noise voltages applied to the input of the Audio Compensator are -110 DBM, or less than 3 microvolts. To avoid lowering the signal to hum ratio of the Audio Compensator, by adding hum voltages to the input, extreme care must be taken in its installation. We offer the following recommendations as a guide to installation:

1. Connect inputs of Audio Compensator as outlined on the table below.

CHANNEL	FOR USE WITH	INPUT (FOR 2.5 V. OUTPUT)		GAIN	REMARKS
		MIN.	MAX.		
1 & 2	AM-FM Tuners Wire Reproducers Tape Reproducers Crystal or Ceramic cartridges Crystal Microphones	70 MV.	20 V.	32 db	Input levels in excess of .07V should be reduced by potentiometers on back panel.
3	Low Impedance Microphone	10 MV.	1 V.	50 db	Input levels in excess of 10 MV should be reduced by potentiometer on back panel.
4	High level Magnetic cartridges. (Terminated for Pickering cartridge)	30 MV.	150 MV.	40 db	See text for operation of these channels.
5	Low level magnetic cartridges or amplitude responsive cartridges such as FM or ceramic	10 MV.	50 MV.	50 db	

The Audio Compensator and magnetic phonograph cartridges should be mounted at least two feet from power transformers.

Inter-unit cables provide a complete ground system. Alternate ground wires create ground loops which will usually increase hum level.

4. The heaters of the 12AX7 tubes used in the C-8 are returned to ground through a hum reducing potentiometer in the power amplifier. Heaters of tubes used in the C-8P are returned to ground through a hum reducing potentiometer in the power supply. This control requires an initial adjustment for minimum hum, and should be readjusted each time one or more tubes are replaced.
5. Grounding the turntable motor frame to the Audio Compensator chassis near the input jacks may reduce the hum level on the phonograph channels.

OUTPUT CONNECTIONS

Three outputs are provided: one auxiliary and two main outputs.

The auxiliary output may be used for recording tape from any source connected to the Audio Compensator. The Selector switch, Bass and Treble compensation switches, and Rumble Filter are effective at this output. Adjustment of the Bass and Treble tone controls, Aural Compensator and Volume control may be made for monitoring purpose and will not affect the recorded signal. The auxiliary output delivers a signal of one volt.

All controls are effective at the main outputs, which are available at the octal socket labeled "INTER-UNIT CABLE" between pins #1 and #2 (pin #1 is ground), and at the RETMA pin jack labeled "MAIN OUTPUT". The inter-unit cable connecting the C-8 to any McIntosh power amplifier uses the octal socket output. The pin jack output may be used for driving a second power amplifier if so desired.

The main and auxiliary output jacks are fed from cathode followers. The input impedance of devices connected to these outputs should be 50,000 ohms or greater, and the capacitive reactance of audio cables connecting these devices should not be less than 8,000 ohms at 20,000 cycles. This is the reactance of a capacity of 1000 mmf. Audio cable having a capacity of 25 mmf per foot may be 40 feet long.

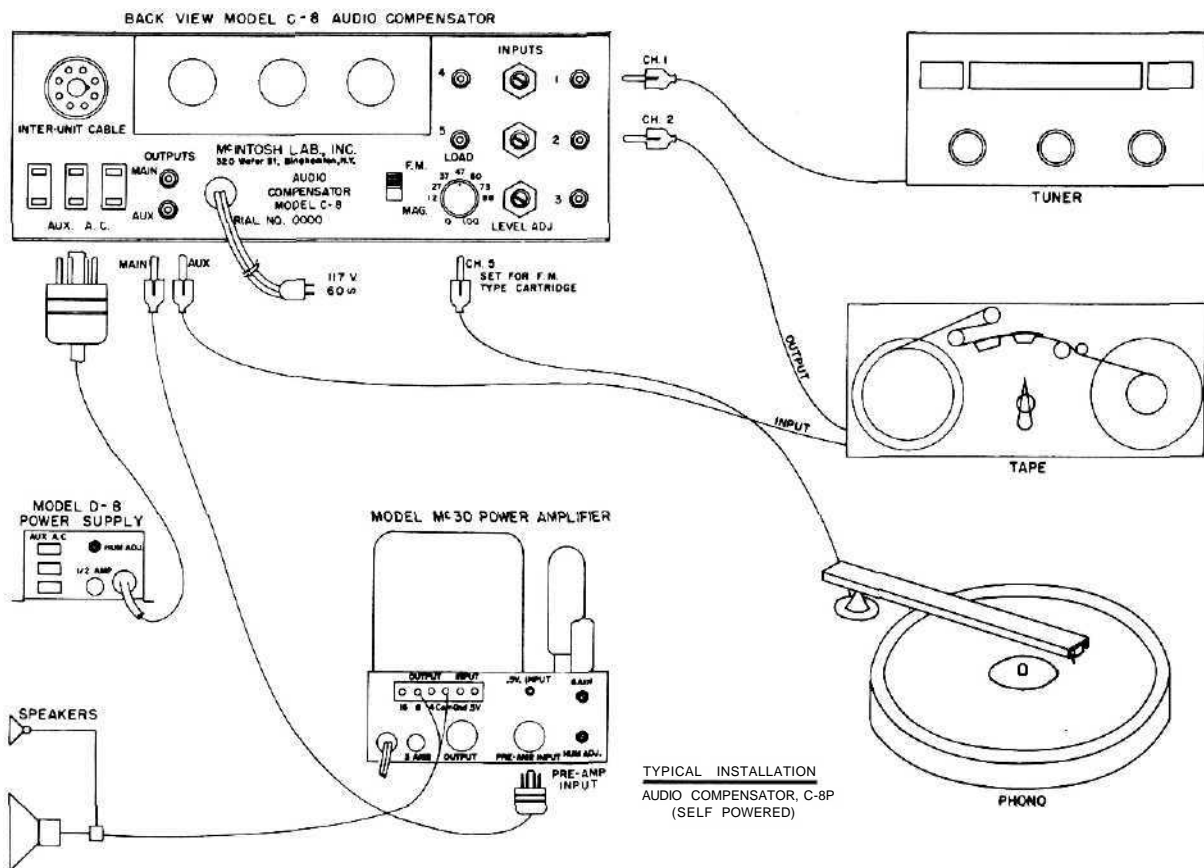
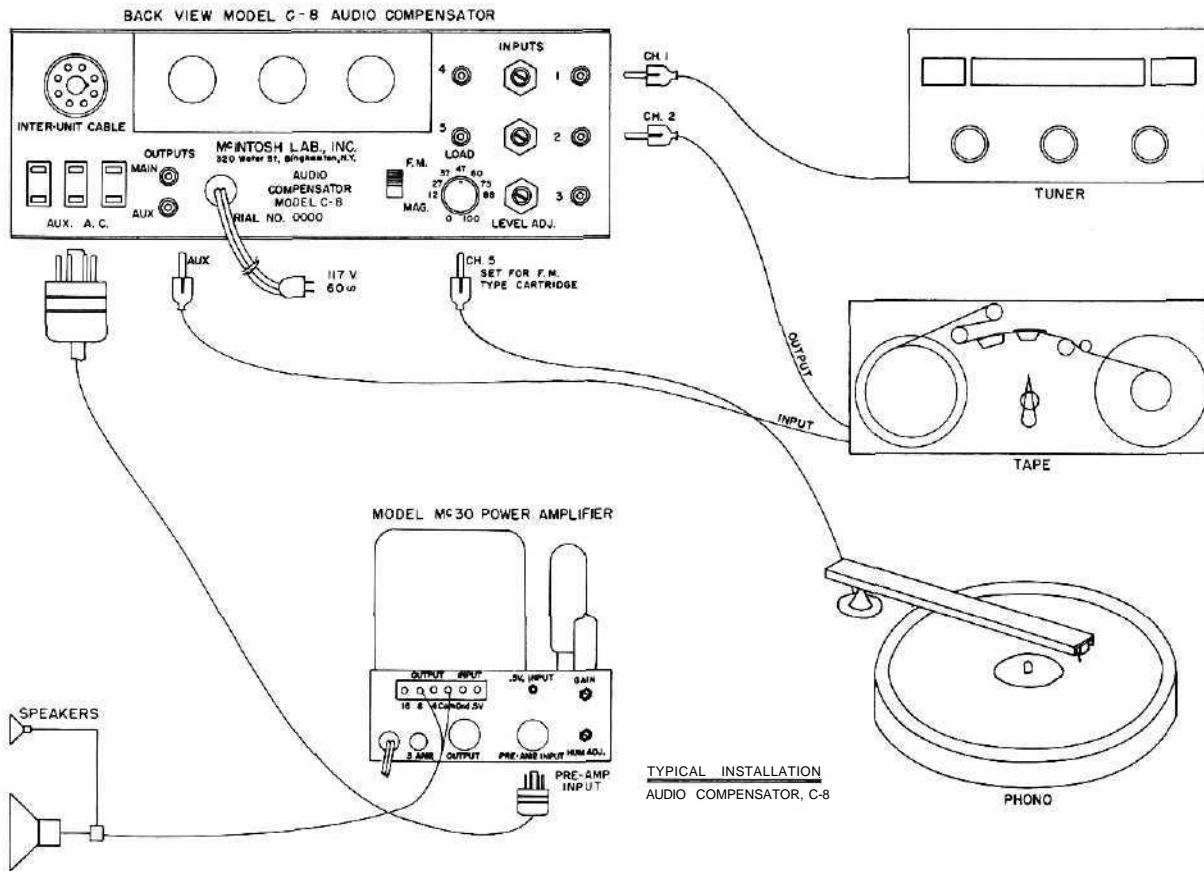

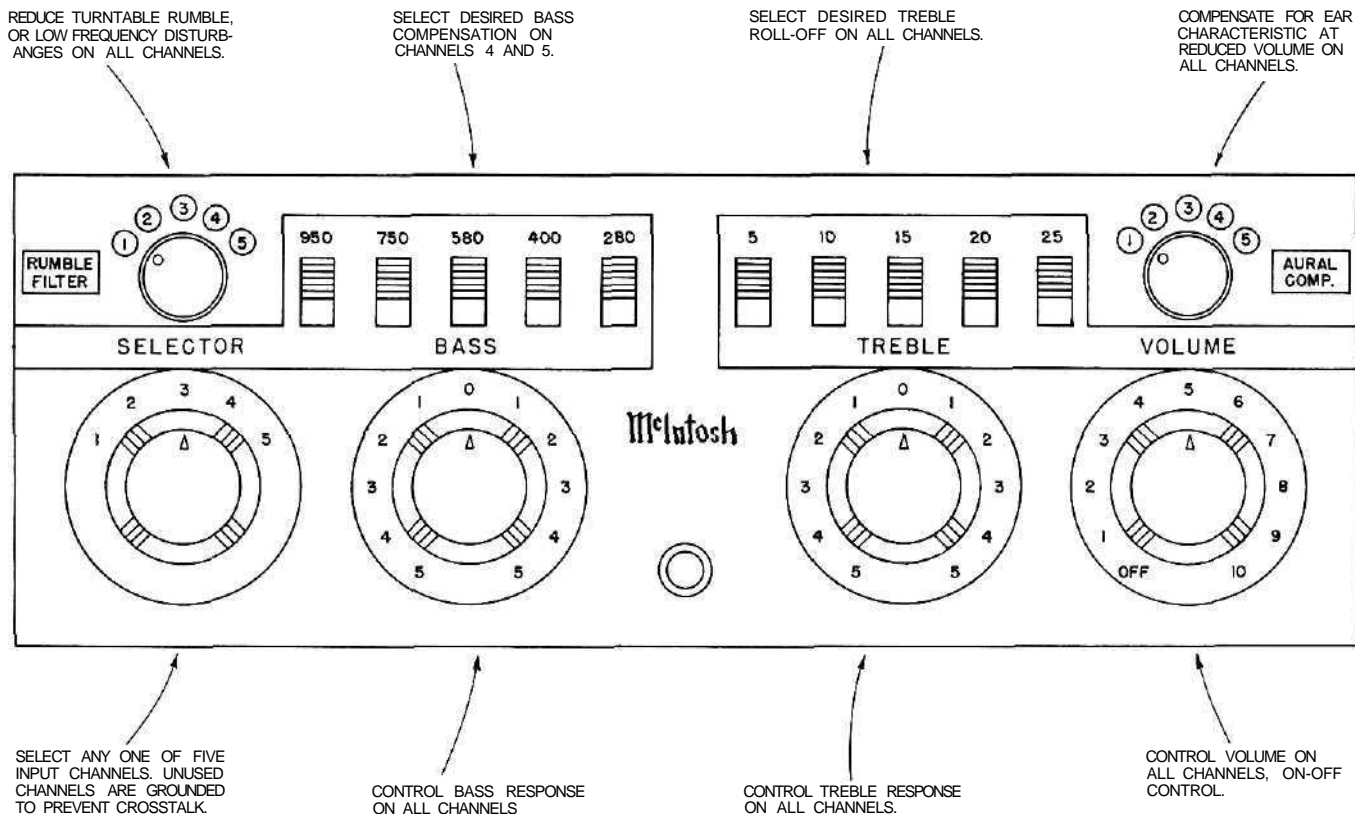

Channels 1 and 2:

Channels 1 and 2 are each terminated by a potentiometer mounted on the back panel which should be used to reduce signal input to these channels if in excess of .07 volts. Correct adjustment occurs when the sound level of channels 1 and 2 is equivalent to that of channels 4 or 5. High impedance sources, such as crystal microphones and the detector output of tuners, may be connected directly to these channels since they have an input impedance of 660,000 ohms.

Channel 3:

Channel 3 is terminated by a 100,000 ohm potentiometer mounted on the back panel which should be used to reduce signal input to this channel if in excess of 10 MV. Low impedance microphones in conjunction with an input transformer, such as McIntosh M-107, may be used on this channel.

Channels 1, 2 and 3 provide flat amplification from 20 to 20,000 cycles. All

front panel controls are effective, with the exception of the Bass Compensation switches, and may be used to alter the response as desired.

Channel 4:

Channel 4 is equalized for use with high level magnetic cartridges delivering 30 MV of signal. It is terminated for use with the Pickering cartridge. Channel 4 may be modified for use with other high level magnetic cartridges by changing the terminating pad of R6 and R7, or may be used for a second low level cartridge by replacing R6 and R7 with a single terminating resistor as recommended by the cartridge manufacturer.

Channel 5:

Channel 5 is equalized for use with low level magnetic cartridges such as G.E., Audax, or Fairchild with input transformer. A variable terminating control is provided, and a switch for selecting either magnetic cartridges (velocity responsive), or amplitude responsive cartridges, such as a ceramic or F.M. type.

When using a magnetic cartridge this switch should be in the "MAG" position and the control labeled "LOAD" should be adjusted to the resistance recommended by the manufacturer. High frequency roll-off of the cartridge may be obtained by decreasing the recommended load. The load control is calibrated from "0" to "100" with each calibration representing thousands of ohms.

Amplitude responsive cartridges may be used on channel 5 to allow full use of the extremely flexible compensation available. By placing the slide switch in position "F.M." and the "LOAD" control to "100", cartridges of this type may be used.

All controls are effective on channels 4 and 5.

The Bass and Treble compensation switches may be used to compensate recordings as recommended by the manufacturer or to adjust the compensation for a more pleasing tonal balance for the listener. The Bass and Treble tone controls are independent of the compensation switches and may be used as fine adjustments in conjunction with these switches. In addition, a rumble filter is provided to reduce turntable "wow" and "rumble".

The five position channel Selector switch may be used to select any of the five input channels available.

The Volume control selects the desired listening level and since it is located at the output of the Audio Compensator, the high signal to noise ratio of the unit is maintained at all levels. By properly adjusting the input potentiometer on channels

1, 2 and 3 the volume level can be held equal for all channels; the signal will remain at a constant loudness when switching from one channel to another. The master off-on switch is attached to the volume control. This switch controls the three auxiliary A.C. outlets on the rear panel of the Audio Compensator as well as the three auxiliary A.C. outlets on the power supply of the C-8P.

The aural compensator may be used to compensate for the response characteristic of the ear at reduced volume. This control decreases the mid-range frequencies while leaving the low and high frequencies at relatively constant intensity. By reducing volume level with this control proper balance of the program material can be maintained.

GUARANTEE

We guarantee the performance of this equipment and the mechanical and electrical workmanship to be free of serious defects for a period of 90 days. This guarantee does not extend to components damaged by improper use nor does it extend to transportation to and from the factory.

McINTOSH LABORATORY INC.
320 Water Street
Binghamton, N.Y., U.S.A.

ELECTRICAL AND MECHANICAL SPECIFICATIONS

Power Source	C-8: Any McIntosh Power Amplifier C-8P: Self-powered
Output	Main: 2.5 volts Auxiliary: 1 volt
Input level	Channels 1 & 2: 70 MV-20 volts Channel 3: 10 MV Channel 4: 30 MV (Magnetic Cartridge) Channel 5: 10 MV (Magnetic or constant amplitude cartridge)
Frequency Response	See Graphs
Harmonic Distortion	Less than .3% at 2.5 volts output, 20-20,000 cycles
Hum and Noise	-110 db (2.5 microvolts) or lower, (referred to input) 0 db = .775 volts
Size Front Panel	C-8: 10" x 3-1/2" x 7-1/2" ¹¹ 11" x 4-1/4" C-8P: Same D-8 (Power supply section of C-8P): 5-1/2"x4-3/4"x2-3/8"
Weight	C-8: 6 lbs. C-8P: 8 lbs.

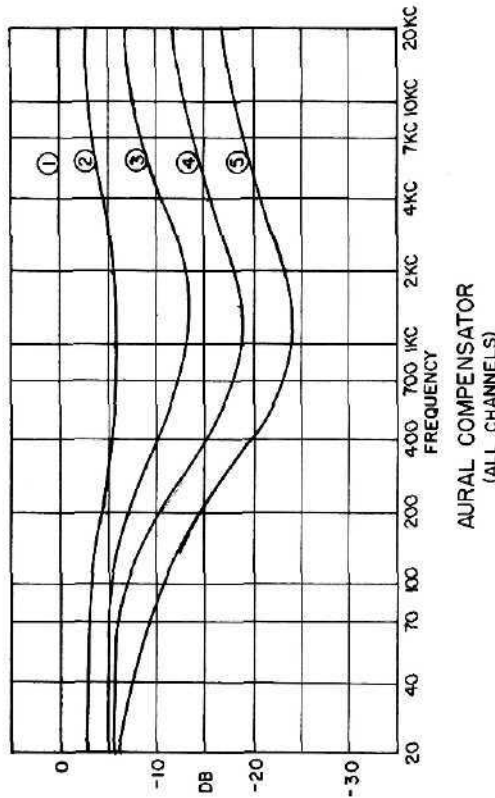
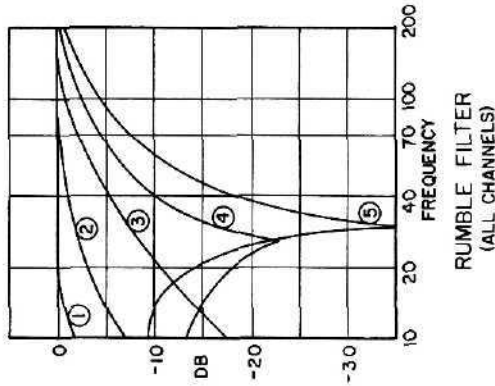
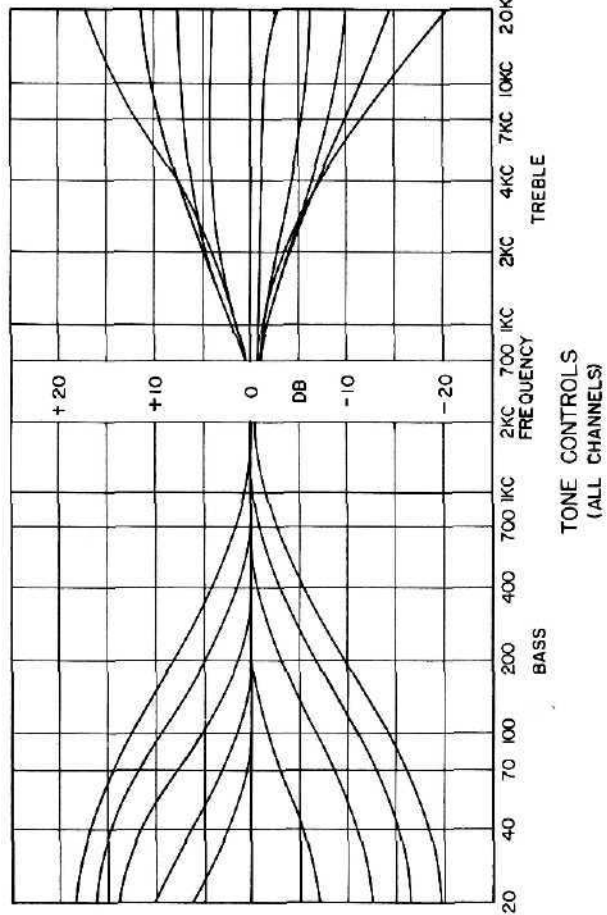
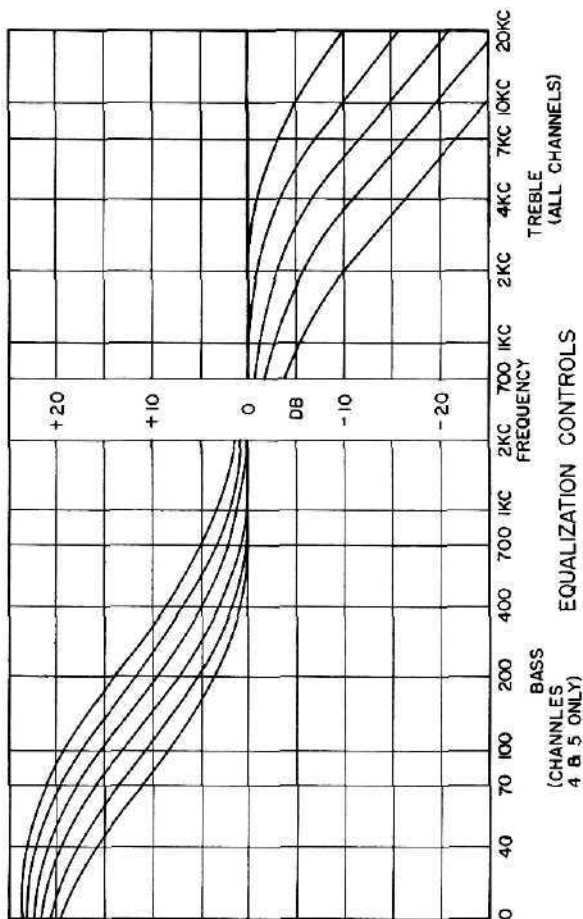

CONTROL CURVES FOR MODEL C-8
AUDIO COMPENSATOR

③ CONTROL POSITION

MCINTOSH LABORATORY, INC.

VOLTAGE AND RESISTANCE CHART

Resistances measured to ground with pin #4 of inter-unit cable socket shorted to pin #1

D.C. Voltages measured with VTVM to ground using D-8 power supply.

Signal voltage measured with all controls in flat position, 1000 cycle signal of 10 MV in channel 3, volume control fully on, and with a VTVM.

Tube	Pin No.	Resistance	D.C. Voltage	Signal Voltage
Input Tube	1	430K	110V	17 MV
	2	1M	0	10 MV
	3	4.1K	1.2V	9.5 MV
	4 & 5	*0-65 ohms	*0-4.8 V.A.C.	--
	6	440K	108V	1.25V
	7	1M	0	17 MV
	8	1.8K	1.2V	0
	9	*0-65 ohms	*0-6.3 V.A.C.	--
	Center Tube	1	110K	195V
2		440K	108V	1.25V
3		330K	110V	1.2V
4 & 5		*0-65 ohms	*0-4.8 V.A.C.	—
6		110K	195V	0
7		200K	45V	1.0V
8		102K	55V	1.1V
9		*0-65 ohms	#0-6.3 V.A.C.	--
Output Tube		1	340K	160V
	2	**0-1 meg	0	95 MV
	3	1.8K	1.2V	14 MV
	4 & 5	*0-65 ohms	*0-4.8 V.A.C.	--
	6	12K	95V	0
	7	1.1M	25V	2.65
	8	102K	350V	2.85
	9	*0-65 ohms	*0-6.3 V.A.C.	--

* Depends on position of hum reducing potentiometer.

** Depends on position of Bass potentiometer. 100K, Bass at "0"

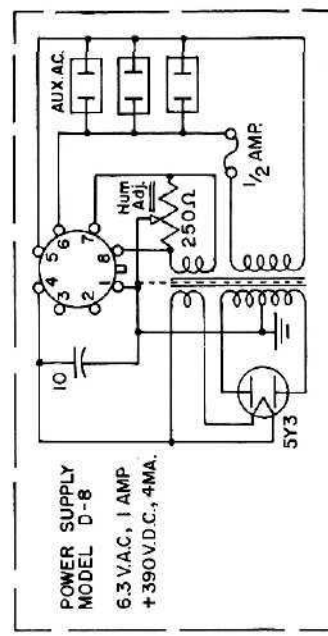
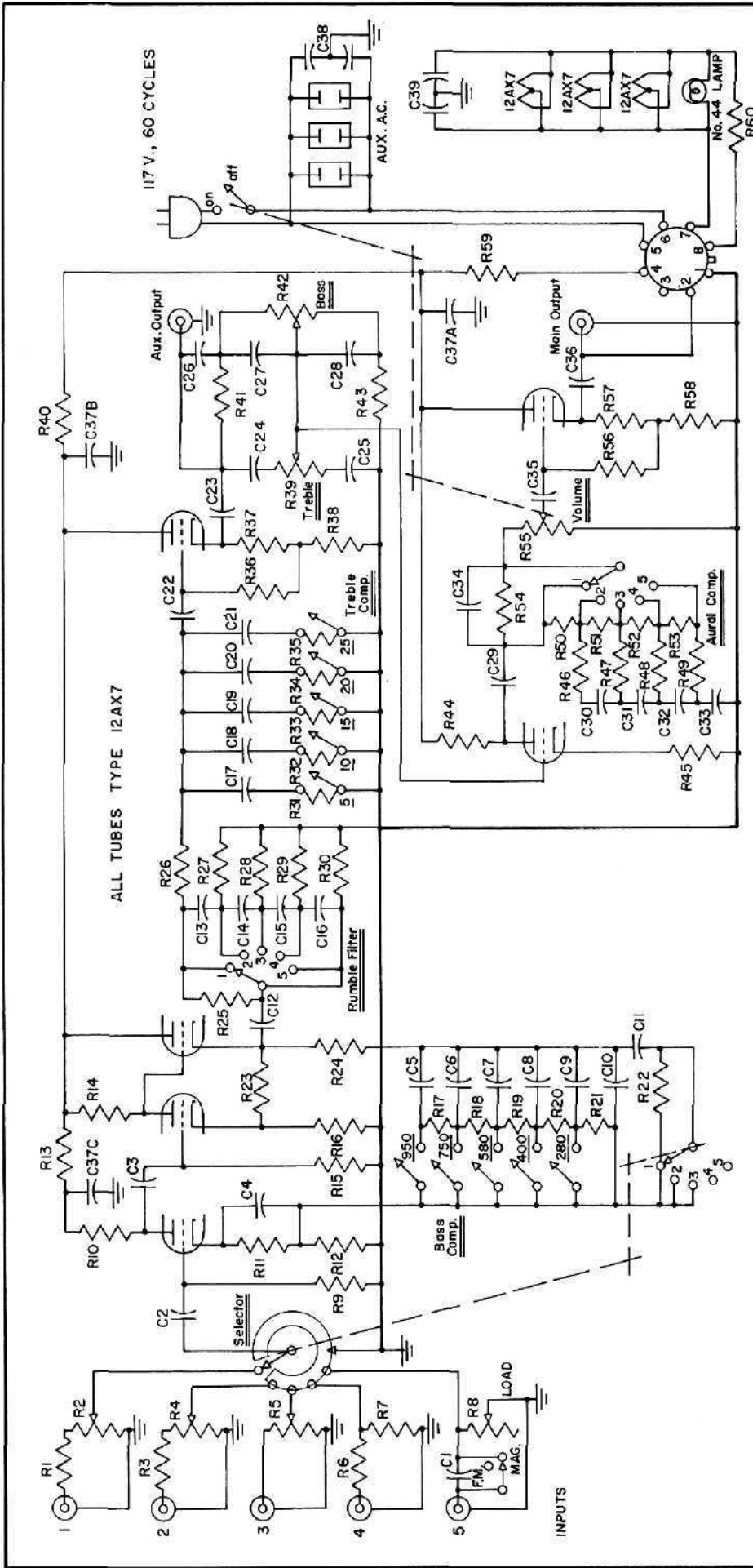

NOTE: On Inter-Unit Cable furnished with C-8, pins 5 and 6 are not connected.

- R1 560K Pot
- R2 100K Pot
- R3 Level Adj.
- R4 560K Pot
- R5 100K Pot
- R6 18K Pot
- R7 10K Pot
- R8 100K Pot
- R9 1M Pot
- R10 220K, 1W
- R11 3.3K, 1W
- R12 75K, 1W
- R13 100K, 1W
- R14 330K, 1W
- R15 1M
- R16 1.8K, 1W
- R17 22M
- R18 22M
- R19 22M
- R20 22M
- R21 22M
- R22 22M
- R23 330K
- R24 100K
- R25 3.9M
- R26 100K
- R27 680K
- R28 330K
- R29 220K
- R30 1M
- R31 10M
- R32 10M
- R33 10M
- R34 10M
- R35 10M
- R36 100K
- R37 1.8K
- R38 100K
- R39 100K
- R40 250K Pot
- R41 1.8K, 1W
- R42 100K
- R43 10K
- R44 330K
- R45 1.8K
- R46 180K
- R47 68K
- R48 33K
- R49 15K
- R50 680K
- R51 10M
- R52 10M
- R53 10M
- R54 330K Pot
- R55 Volume
- R56 1M
- R57 1.8K
- R58 100K
- R59 12K, 2W
- R60 2 ohms, 10W
- C1 22M
- C2 22M
- C3 330K
- C4 100K
- C5 3.9M
- C6 100K
- C7 680K
- C8 330K
- C9 220K
- C10 1M
- C11 10M
- C12 10M
- C13 330K Pot
- C14 10M
- C15 10M
- C16 100K
- C17 1.8K
- C18 100K
- C19 100K
- C20 250K Pot
- C21 Treble
- C22 100K
- C23 100K
- C24 1M Pot
- C25 Bass
- C26 .01, 10%
- C27 .0022, 10%
- C28 .022, 10%
- C29 .1
- C30 .0047, 10%
- C31 .01, 10%
- C32 .022, 10%
- C33 .022, 10%
- C34 .330
- C35 .033
- C36 .47
- C37 20mf, 400V.
- C38 30mf, 300V.
- C39 30mf, 250V.
- C37C Dual .01
- C38 Dual .01
- C39 Dual .01

Unless stated otherwise, component values are as follows:
 Resistance in ohms, 10%, 1/2 watt.
 K-X 1000, M-X 1,000,000
 Capacity less than unity in mf, 20%, 400V.
 Capacity greater than unity in mmf, 20%, 500V.

MCINTOSH LABORATORY, INC.
 320 Water Street, Binghamton, New York
 MODEL C-8P, AUDIO COMPENSATOR